

Cylindrical cage for pole top

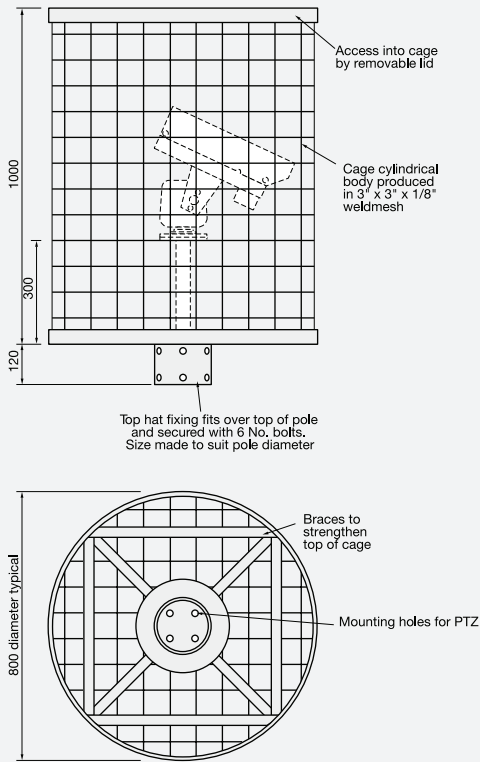

Cages can be painted matt black over galvanizing to reduce I/R reflection.

Diameter of cage to suit camera assembly housing

Cage Ø	Part No.
500	PACPT/500
800	PACPT/800
1000	PACPT/1000
1200	PACPT/1200

Pole top mounted cage

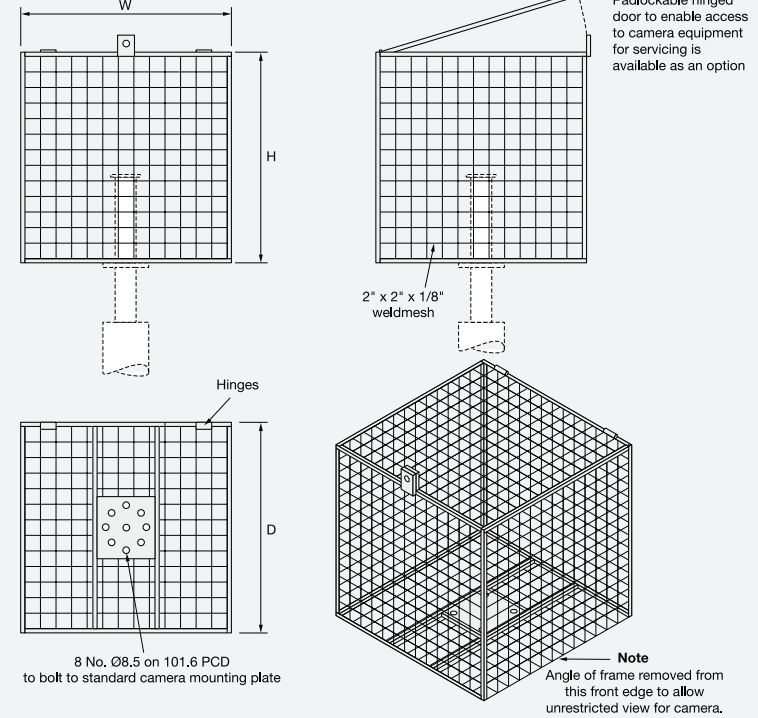

Cages can be painted matt black over galvanizing to reduce I/R reflection.

Typical Dimensions

	D	H	W
Fixed camera	500	500	500
PTZ Camera	1000	1000	1000

Dimensions are typical and can vary to suit application. Please specify.

Cage Type	Part No.
Fixed camera	AFCPT
PTZ camera	PACPT

Ornate styles (All bracketry available in all 3 styles, other styles made to order)

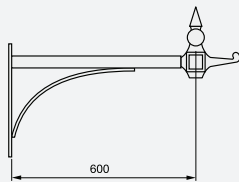

Simple Ornamental

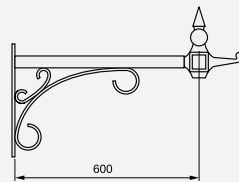

Newcastle Scroll

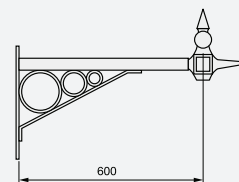

Edinburgh Hoop

Pole top mounting bracket PT-1689-N

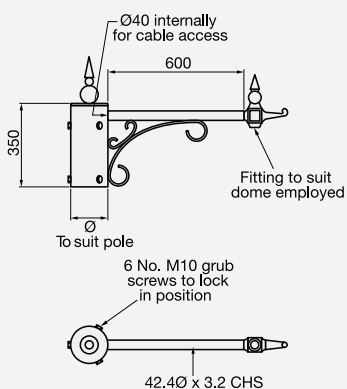

Ornate pole top mount bracket for PTZ camera PT-1689-N/SPT

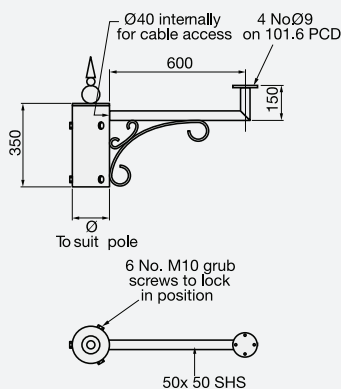

Ornate pole mounting bracket PMB (Ø*)1689-N (*Pole diameter)

